

Piezo ceramic elements and products view.

Shapes of element products

Disks

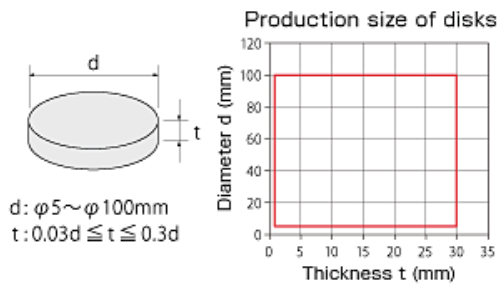

Semicircles

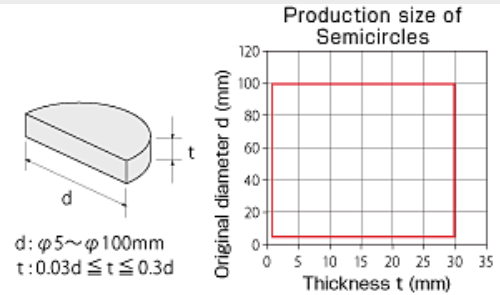

Columnar shapes

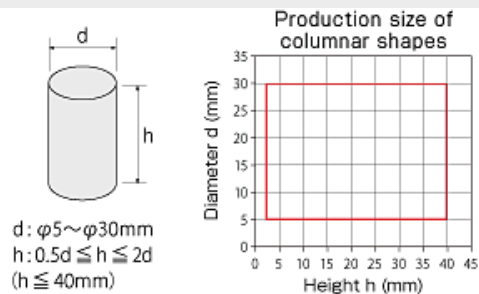
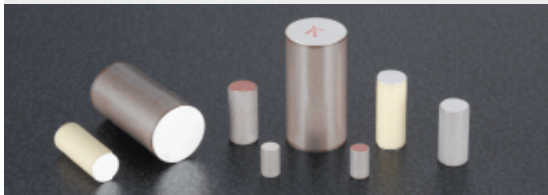

Square plates

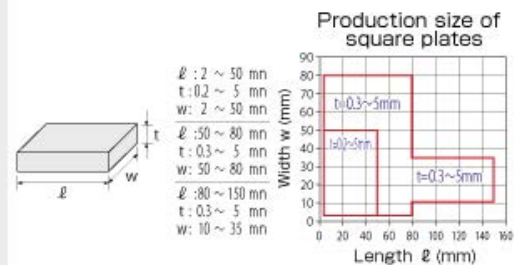
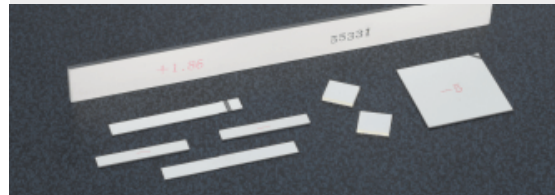

Prismatic shapes

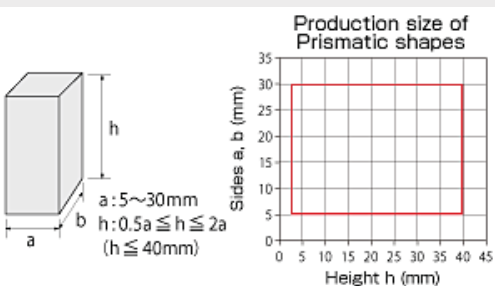

Annular shapes

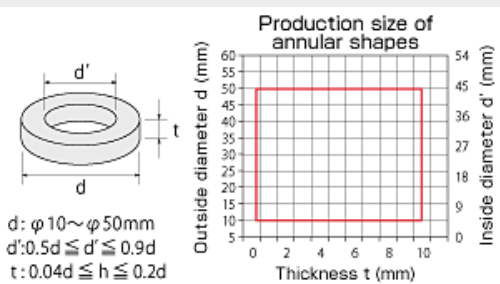

Cylindrical shapes

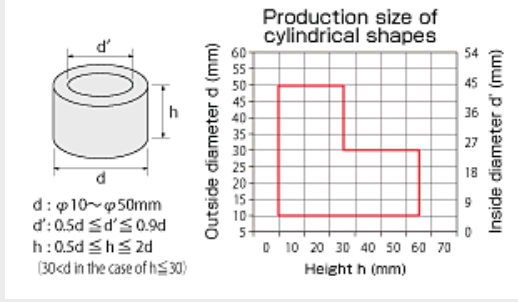

Spherical shapes

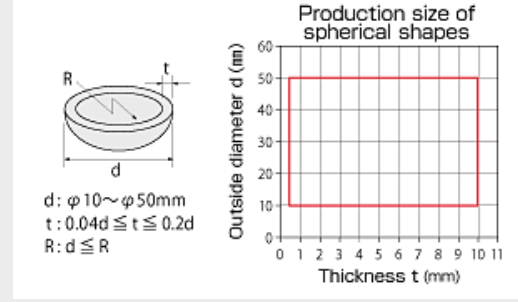

Half-cylindrical types

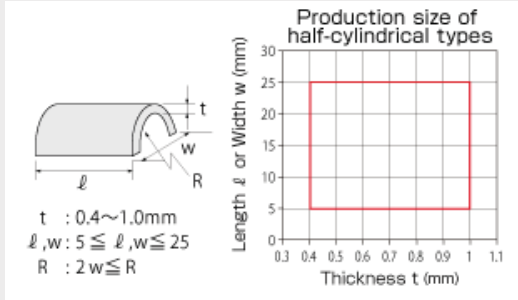

Other special shapes

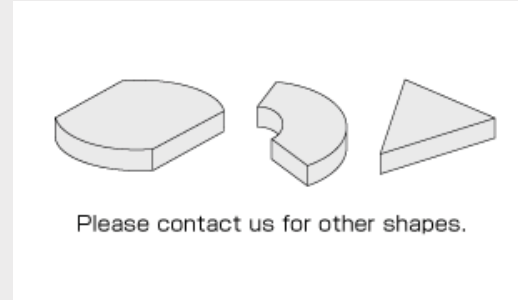

Multilayer piezo elements

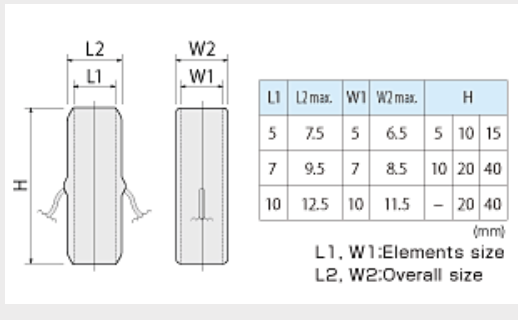
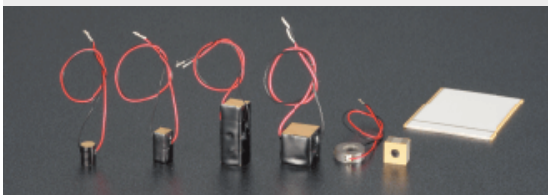

Composite piezo elements

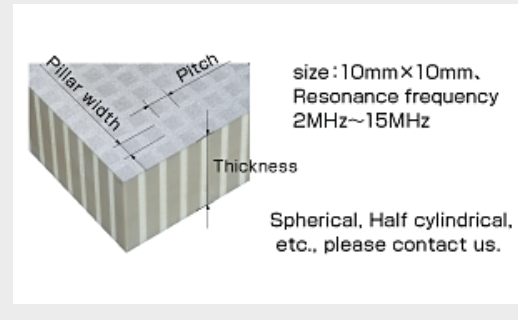
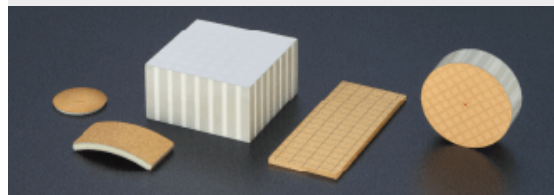

Production is possible size depends on the ceramic material and specifications.
 For out-of-range size, please contact us.