

PIEZO CERAMICS

About the piezoelectric property of a material characteristics table.

The piezoelectric property has shapes and the conditions of a direction. This condition is expressed in the vector and a symbol of tensor quantity. The superscript and subscript of this symbol have a meaning. Those outlines are summarized.

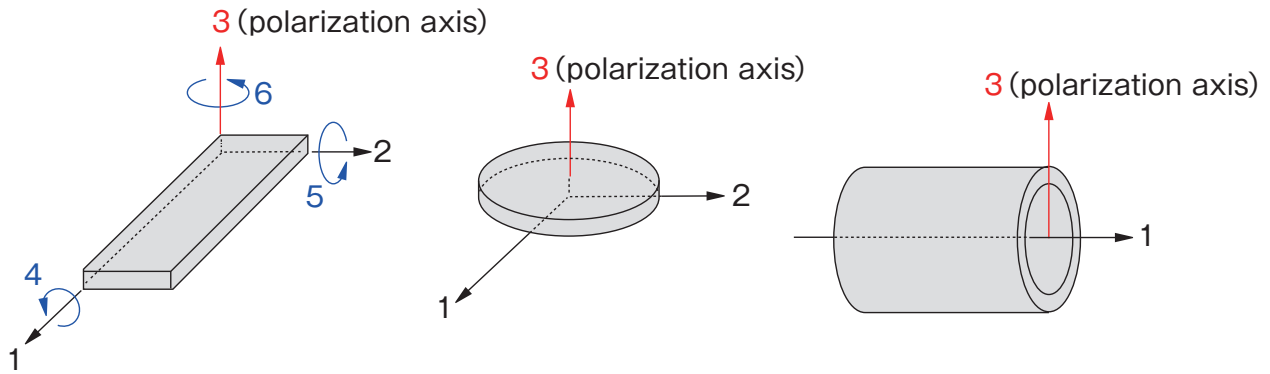

S_{11}	g_{33}
└ Stress or strain is a direction of 1 axis.	└ Stress or strain is a direction of 3 axis.
└ Strain or stress is a direction of 1 axis.	└ Normal direction of the electrode face is 3 axis.
c_{55}	d_{15}
└ Shear stress is the rotatory direction of 2 axes.	└ Shear strain is the rotatory direction of 2 axes.
└ Shear strain is the rotatory direction of 2 axes.	└ Normal direction of the electrode face is 1 axis.
d_{31}	ϵ_{33}
└ Strain or stress is a direction of 1 axis.	└ Dielectric displacement is a direction of 3 axis.
└ Normal direction of the electrode face is 3 axis.	└ Normal direction of the electrode face is 3 axis.

- k_p, N_p : Constants of the radial direction of the disk which has orthogonal electrode face in a polarization axis.
- k_t, N_t : Constants of the thickness direction of the plate which has orthogonal electrode face in a polarization axis.
- $k_{31}, N_{31}, d_{31}, g_{31}$: Constants of the longitudinal direction of the rectangular plate which has orthogonal electrode face in a polarization axis.
- $k_{33}, N_{33}, d_{33}, g_{33}$: Constants of the polarization direction of the virgulate which has orthogonal electrode face in a polarization axis.
- $k_{15}, N_{15}, d_{15}, g_{15}$: Constants of the polarization axis (or orthogonal)-shear direction of the plate which has electrode face in a polarization axis.
- ϵ_{11}^T : Free dielectric displacement of the plate which has electrode face in a polarization axis (at constant stress).
- ϵ_{33}^T : Free dielectric displacement of the plate which has orthogonal electrode face in a polarization axis (at constant stress).
- ϵ_0 : Electric constant. ($=8.854 \times 10^{-12}$ F/m)
- Y_{11}^E, S_{11}^E : Transverse elasticity of the electrode face direction of the plate which has orthogonal electrode face in a polarization axis (at constant electric field).
- Y_{33}^E, S_{33}^E : Longitudinal elasticity of the polarization axis direction of the virgulate which has orthogonal electrode face in a polarization axis (at constant electric field).
- Y_{55}^E, S_{55}^E : Shear elasticity of the polarization axis (or orthogonal) direction of the plate which has electrode face in a polarization axis (at constant electric field).

About the piezoelectric property of a material characteristics table.

■Equivalent circuit

The piezoelectric element is expressed by the equivalent circuit of FIG near the resonance frequency.

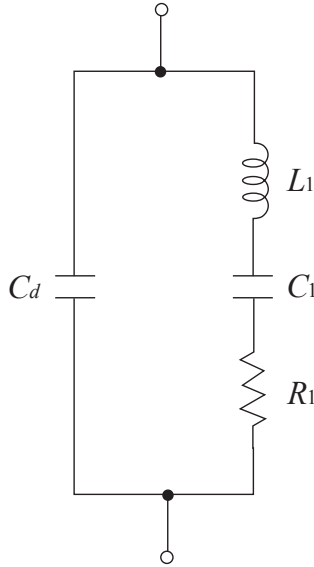

- L_1 : Equivalent inductance
- C_1 : Equivalent capacity
- R_1 : Resonant resistance
- C_d : Damping capacity

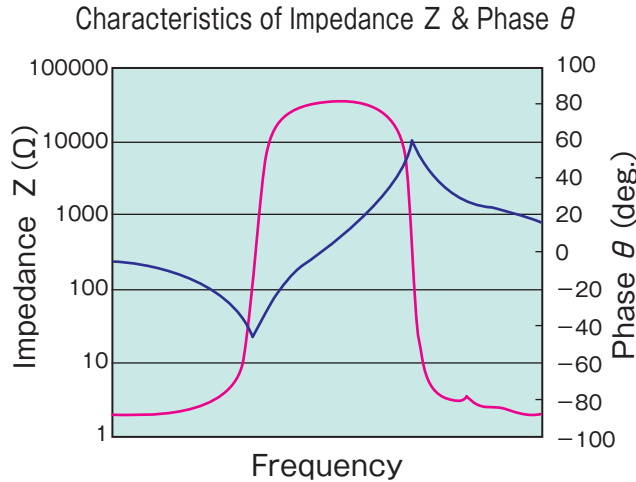

The above chart is a characteristic of the impedance and phase of near the resonance frequency. And C_d is the current component flowing in the piezo element. L_1 and C_1 are the vibration mode of the piezo element. It represents the mechanical vibrations decided by the element size and elastic constant and piezoelectric constant. R_1 represents the mechanical vibration loss.

■Coupling factors k_p , k_t , k_{31} , k_{33} , k_{15}

Electromechanical coupling factor k is a factor represents the electrical and mechanical conversion capacity. It is defined as the square root of the ratio of "Arise mechanical energy" and "Given electrical energy", or "Given mechanical energy" and "Arise electrical energy". It is one of an amount representing the piezoelectric effect. The following is a practical formula to calculate the coupling factor k from the resonant frequency and the anti-resonance frequency.

$$\frac{1}{k^2} = a \cdot \frac{f_r}{f_a - f_r} + b$$

f_r : Resonant frequency

f_a : Anti-resonance frequency

Refer to the table on the right, for the coefficient a and b in the formula.

Vibrational mode	a	b	
Width vibration of the plate (k_{31})	0.405	0.595	
Spread vibration of the cylinder (k_{31})	0.500	0.750	
Spread vibration of the disk (k_p)	0.395	0.574	
Longitudinal vibration of the rod (k_{33})	0.405	0.810	
Thickness vibration of the plate (k_t)	0.405	0.810	
Thickness-shear vibration	Transversal effect (k_{15})	0.405	0.595
	Longitudinal effect (k_{15})	0.405	0.810

Poisson's ratio $\sigma = 0.3$

About the piezoelectric property of a material characteristics table.

■ Frequency constants N_p , N_t , N_{31} , N_{33} , N_{15}

A frequency constant N serves as length ℓ and the product with resonance frequency f_r of the corresponding direction. It's used to determine the size and the resonance frequency. The frequency constant according to vibration mode is shown by the following formula.

Radial vibration of the discs	$N_p = f_r \cdot D$	Thickness vibration of the plates	$N_t = f_r \cdot t$
Longitudinal vibration of the plates	$N_{31} = f_r \cdot \ell$	Thickness shear vibration of the plates	$N_{15} = f_r \cdot t$
Longitudinal vibration of the rods	$N_{33} = f_r \cdot \ell$		

■ Dielectric constant ε_{11}^T , ε_{33}^T & Capacitance C^T

The dielectric constant ε^T is defined by the electric displacement arising when given an electric field. Used for the analysis of the piezoelectric constant by measuring the capacitance C^T at a sufficiently lower frequency than the resonant frequency. The ratio of the permittivity ε_0 in vacuum is the relative permittivity $\varepsilon^T/\varepsilon_0$. These relationships are expressed by the following equation.

$$C^T = \varepsilon^T \cdot \frac{A}{t}$$

The material properties table becomes the following formula to describe the relative permittivity.

$$C^T = \frac{\varepsilon^T}{\varepsilon_0} \cdot \varepsilon_0 \cdot \frac{A}{t}$$

A : Electrode area [m²] t : Interelectrode distance [m]

$$\varepsilon_0 = 8.854 \times 10^{-12} \text{ [F/m]}$$

■ Piezoelectric constants d_{31} , d_{33} , d_{15} , g_{31} , g_{33} , g_{15}

Piezoelectric constant is a constant that represents the largeness of the piezoelectric effect along with the coupling factor. In the piezoelectric constants there are four constants of the piezoelectric strain constant d , piezoelectric voltage constant g and the piezoelectric stress constant e and h . Usually, d constant and g constant are used. These are defined as follows.

$$d = \frac{\text{Arisen strain}}{\text{Given field strength}} \left(\frac{\frac{m}{m}}{\frac{V}{m}} = \frac{m}{V} \right) = \frac{\text{Arisen charge density}}{\text{Given stress}} \left(\frac{\frac{C}{m^2}}{\frac{N}{m^2}} = \frac{C}{N} \right)$$

About the piezoelectric property of a material characteristics table.

$$g = \frac{\text{Arisen field strength}}{\text{Given stress}} \left(\frac{\frac{V}{m}}{\frac{N}{m^2}} = \frac{V \cdot m}{N} \right) = \frac{\text{Arisen strain}}{\text{Given charge density}} \left(\frac{\frac{m}{C}}{\frac{m^2}{C}} = \frac{m^2}{C} \right)$$

In the definition of the previous formula, the amount of displacement with respect to the applied voltage from the d constant can be calculated. Also from the g constant, can be calculated output voltage with respect to the applied force. e constant and h constant is in a reciprocal relation with the g constant and d constant.

■ Elastic constants $Y_{11}^E, s_{11}^E, Y_{33}^E, s_{33}^E, Y_{55}^E, s_{55}^E$

A ratio with the longitudinal strain of the same direction as perpendicular stress is Young's modulus Y . Without considering the other direction, if a particular direction the target, handled also as elastic stiffness c . The elastic compliance s is in a reciprocal relation with the Young's modulus Y .

$$Y = c = \frac{1}{s}$$

In the piezoelectric ceramics it is directly related to the frequency constant that determines the resonance frequency. And is also the amount related to the generated force.

■ Poisson's ratio σ

A poisson's ratio is defined by the ratio of the transversal strain and a longitudinal strain, which arisen in perpendicular stress.

$$\sigma = \frac{\alpha}{\beta} = -\frac{s_{12}^E}{s_{11}^E}$$

Poisson's ratio is particularly the amount related to the resonant frequency of the binding region.

■ Dielectric loss $\tan \delta$

When in the piezoelectric body of lossless applying a sine wave AC electric field E of angular frequency ω , electric displacement \dot{D} vibrates in $2/\pi$ phase advanced for the electric field \dot{E} . In practice, electric displacement \dot{D} is δ only delayed, and arisen the loss of the phase difference. This loss will be action such as to be transformed to the dielectric heat generation. (Please refer to the following FIG.) There is a relation, as shown in the following formula to between C_d and R_l and $\tan \delta$ of the equivalent circuit of FIG.

About the piezoelectric property of a material characteristics table.

Vector FIG of a piezoelectric body having a loss

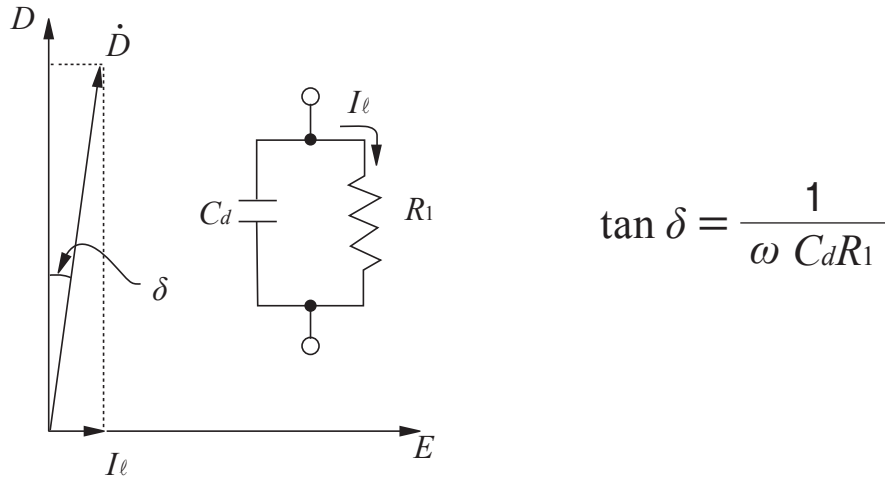

■ Mechanical quality factor (Mechanical Q) Q_m

The piezoelectric body has elastic loss like the dielectric loss. Against stress by AC electric field, arising a phase difference of δ_m to the strain.

$$\tan \delta_m = \frac{1}{Q_m}$$

This Q_m is the mechanical Q_m . The relation between the equivalent circuit is expressed by the following formula.

$$Q_m = \frac{1}{\omega_s C_1 R_1} = \omega_s L_1 R_1 \doteq \frac{1}{4\pi Z_r C (f_a - f_r)}$$

ω_s : Angular frequency	Z_r : Resonance impedance
C_1 : Equivalent capacity	C : Capacitance
R_1 : Resonant resistance	f_r : Resonance frequency
L_1 : Equivalent inductance	f_a : Antiresonance frequency

The magnitude of the Q_m , it acting on the sharpness of the mechanical vibration in the resonance frequency.

About the piezoelectric property of a material characteristics table.

■ Curie point T_c

The dielectric constant ϵ of the piezoelectric body, will increase to infinity with increasing temperature T . As a result, the crystal becomes unstable and will change rapidly at the temperature θ_0 at which there is a crystal system. This temperature θ_0 is the Curie point. It is the critical temperature at which completely depolarized. Piezoelectricity, will be lost in this temperature. Changes in the dielectric constant ϵ in a high temperature range will be the relationship, such as the following formula .

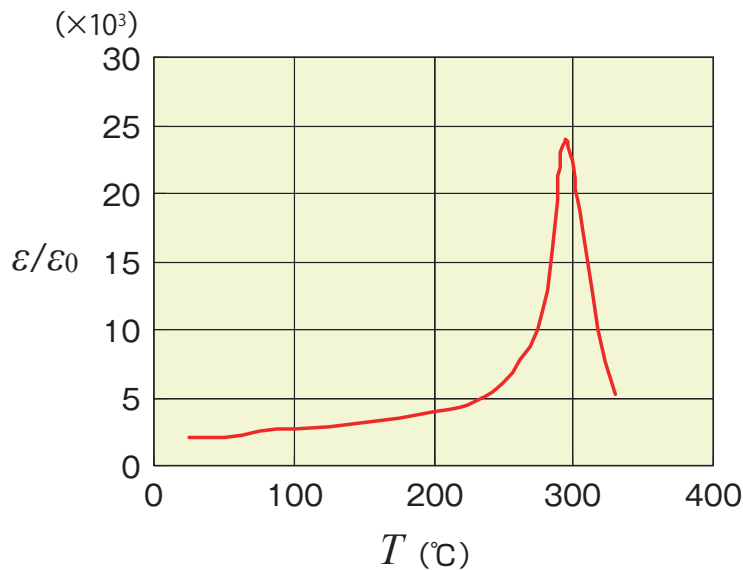

$$\epsilon = \frac{c}{T - \theta_0}$$

(c and θ_0 is constants)

Temperature characteristic example of the dielectric constant of the PZT material

■ Admittance characteristic example of the piezoceramics vibrator

Admittance circle of piezoceramics vibrator

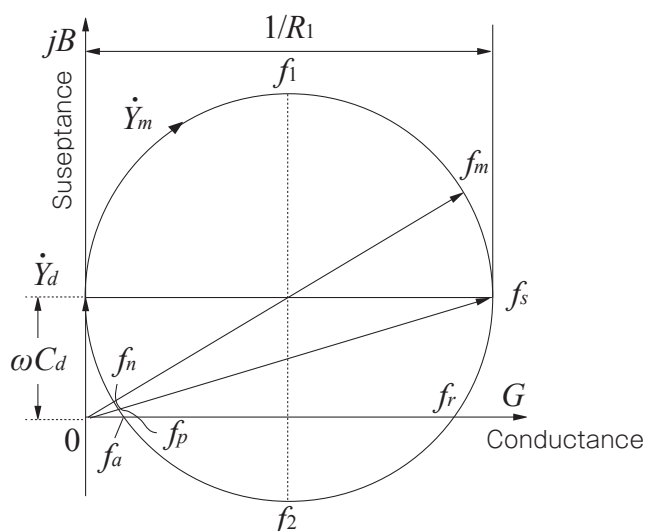

Admittance chart of the vibrator

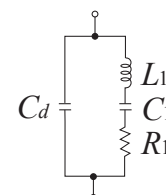
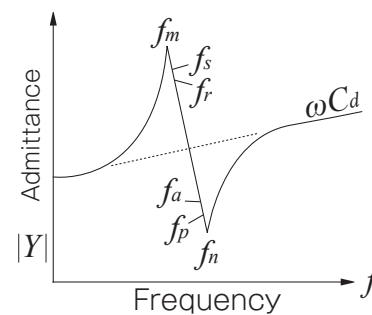

PIEZO CERAMICS

About the piezoelectric property of a material characteristics table.

f_s : Mechanical series resonance frequency (conductance maximum frequency)

f_p : Mechanical parallel resonance frequency



f_r : Resonance frequency } (susceptance=0 or a phase=0 frequency)
 f_a : Antiresonance frequency }

f_m : Frequency which the absolute value of admittance becomes the maximum

f_n : Frequency which the absolute value of admittance becomes the minimum

f_1 : Frequency which a susceptance becomes the maximum } quadrant Frequency
 f_2 : Frequency which a susceptance becomes the minimum }

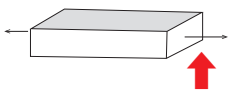
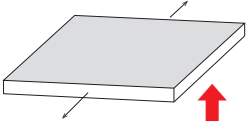
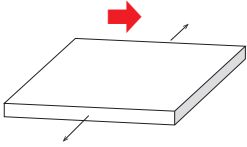
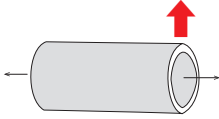
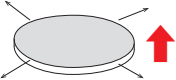
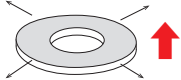
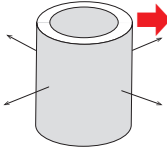
Examples of the vibrator shape and the vibration mode

Vibrator of transversal effect			
			
(a) Extend vibration of the rod	(b) Width vibration of the plate	(c) Width vibration of the plate	(d) Extend vibration of the cylinder
			
(e) Spread vibration of the disk	(f) Spread vibration of the circular ring	(g) Spread vibration of the cylinder	(h) Thickness-shear vibration

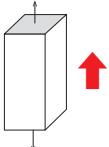
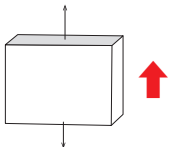
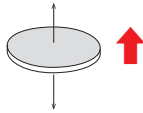
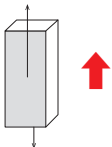
Vibration of longitudinal effect			
			
(i) Longitudinal vibration of the rod	(j) Width vibration of the plate	(k) Thickness vibration of plate	(l) Thickness-shear vibration

↑:Direction of polarization

About the piezoelectric property of a material characteristics table.

■ Basic resonance frequency of each vibrator

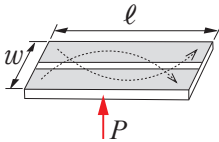
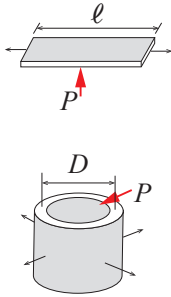
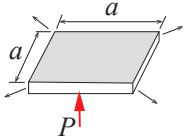
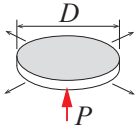
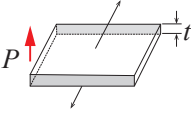
Vibration mode	Vibrator shapes	Resonance frequency of fundamental vibration
Transversal effect	Bending vibration 	$f_r = \frac{\pi}{4\sqrt{3}} \cdot \frac{w}{\ell^2} \cdot \sqrt{\frac{2}{(1+\sigma^E)}} \cdot \sqrt{\frac{1}{\rho S_{11}^E}}$
	Rectangular Vibration [Respiratory vibration] 	$f_r = \frac{1}{2\ell} \sqrt{\frac{1}{\rho S_{11}^E}}$ $f_r = \frac{1}{\pi D} \sqrt{\frac{1}{\rho S_{11}^E (1+\sigma^E)(1-\sigma^E)}}$ <p style="text-align: center;">D : Average diameter</p>
	Area vibration 	$f_r = \frac{1}{2a} \sqrt{\frac{1}{\rho S_{11}^E (1-\sigma^E)}}$
	Radial vibration 	$f_r = \frac{\eta_1}{\pi D} \sqrt{\frac{1}{\rho S_{11}^E (1+\sigma^E)(1-\sigma^E)}}$ <p style="text-align: center;">$\sigma^E = 0.35$ in the case of $\eta_1 = 2.08$</p>
	Thickness-shear vibration 	$f_r = \frac{1}{2t} \sqrt{\frac{C_{55}^E}{\rho}}$

PIEZO CERAMICS

About the piezoelectric property of a material characteristics table.

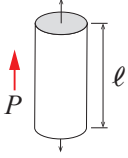
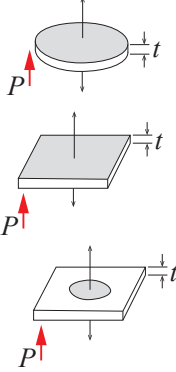
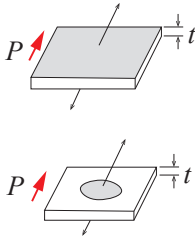
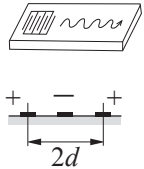
Vibration mode	Vibrator shapes	Resonance frequency of fundamental vibration
Longitudinal effect		$f_r = \frac{1}{2l} \sqrt{\frac{c_{33}^E}{\rho}} = \frac{1}{2l} \sqrt{\frac{(1-k_{33}^2) c_{33}^D}{\rho}}$ $f_a = \frac{1}{2l} \sqrt{\frac{1}{\rho s_{33}^D}} = \frac{1}{2l} \sqrt{\frac{1}{\rho s_{33}^E (1-k_{33}^2)}}$
		$f_r = \frac{1}{2t} \sqrt{\frac{c_{33}^E}{\rho} \cdot \frac{(1-\sigma^E)}{(1+\sigma^E)(1-2\sigma^E)}}$ $f_a = \frac{1}{2t} \sqrt{\frac{c_{33}^D}{\rho}} = \frac{1}{2t} \sqrt{\frac{c_{33}^E}{\rho(1-kt^2)}}$
		$f_r = \frac{1}{2t} \sqrt{\frac{c_{33}^E}{2(1+\sigma^E)\rho}}$ $f_a = \frac{1}{2t} \sqrt{\frac{c_{55}^D}{\rho}} = \frac{1}{2t} \sqrt{\frac{1}{\rho s_{55}^E (1-k_{15}^2)}}$
		$f_r = \frac{v_s}{\lambda} = \frac{v_s}{2d}$ <p>v_s: Basic resonance frequency of each vibrator</p>

$$S_{11}^D = S_{11}^E (1 - k_{31}^2) \quad S_{33}^D = S_{33}^E (1 - k_{33}^2) \quad C_{55}^E = C_{55}^D (1 - k_{15}^2) \quad C_{55}^E = \frac{1}{S_{55}^E}$$

Reference:『THE TECHNICAL HANDBOOK FOR PIEZOELECTRIC CERAMICS』
By Fuji Ceramics corporation, Japan